

KOTRON® SMART RF MODEL 805 TRANSMITTER

Installation and Operating Manual

R.F.
Capacitance
Level
Measurement

7xxx

6xxx

5xxx

4xxx

3xxx

2xxx

1xxx

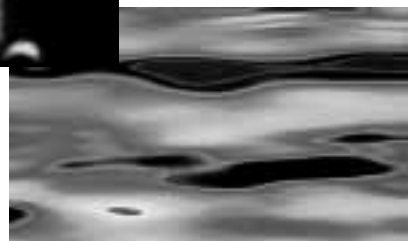

Magnetrol®

UNPACKING

Unpack the instrument carefully. Make sure all components have been removed from the foam protection. Inspect all components for damage. Report any concealed damage to the carrier within 24 hours. Check the contents of the carton/crates against the packing slip and report any discrepancies to Magnetrol. Check the nameplate model number (Model number/approvals as per inserted separate sheet) to be sure it agrees with the packing slip and purchase order. Check and record the serial number for future reference when ordering parts.



These units have been tested to EN 50081-2 and EN 50082-2 and are in compliance with the EMC Directive 89/336/EEC and Directive 94/9/EC for Equipment or protective system for use in potentially explosive atmospheres.

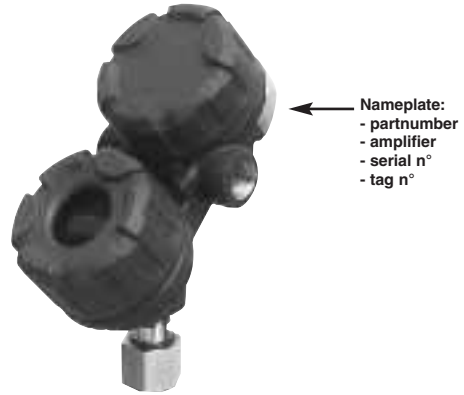

MOUNTING

KOTRON R.F probes

(For installation details see bulletin BE50 - 125)

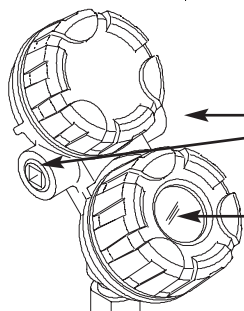
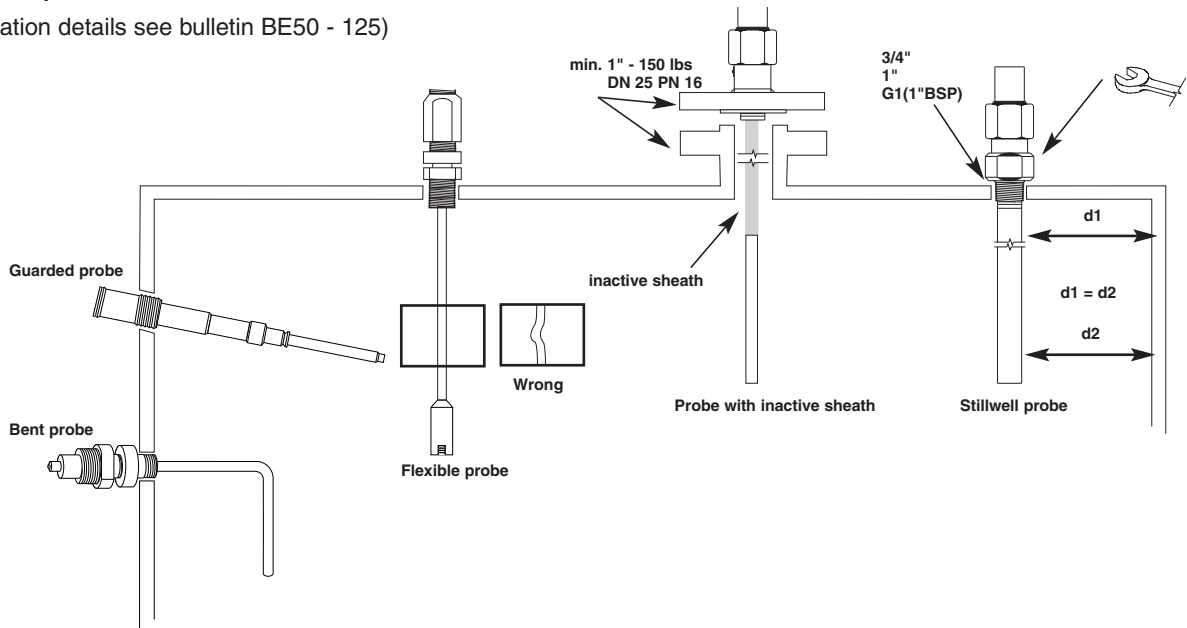

2 cable entries (one plugged): M20 x 1.5, 3/4" NPT or PG 13.5

For replacing electronics only:

The electronic insert can easily be removed by loosening the 3 mounting screws and unplugging the module. The probe wire is fixed to the PCB by means of a spade plug.

(a) Handtighten or use Size: 33 mm (1 1/8") or adjustable wrench

(b) Disconnect white probe wire always at the probe - never at the electronics (see above).

WARNING: Never mount or dismantle a threaded probe by the upper mounting nut for the amplifier (a), ALWAYS use the lower probe mounting nut (b).

WIRING

CAUTION: power must be switched OFF before wiring the unit.

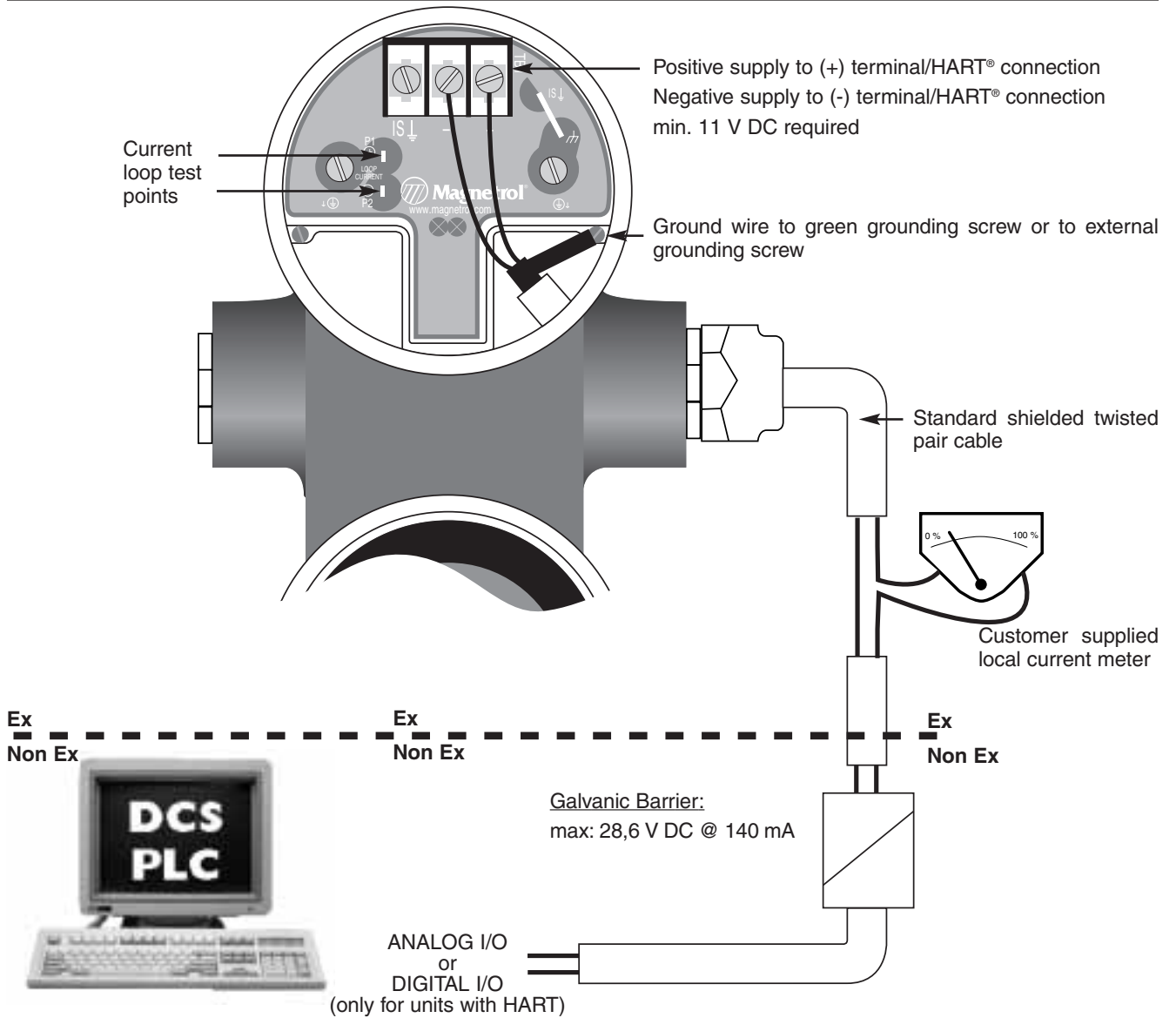

CAUTION: ALWAYS check for proper grounding, Improper grounding will cause malfunction of the unit.

CALIBRATION

NOTE: When connected to an approved barrier, the intrinsically safe electronics of the Kotron 805 allow to remove both covers with power switched on – even if the area is known to be hazardous

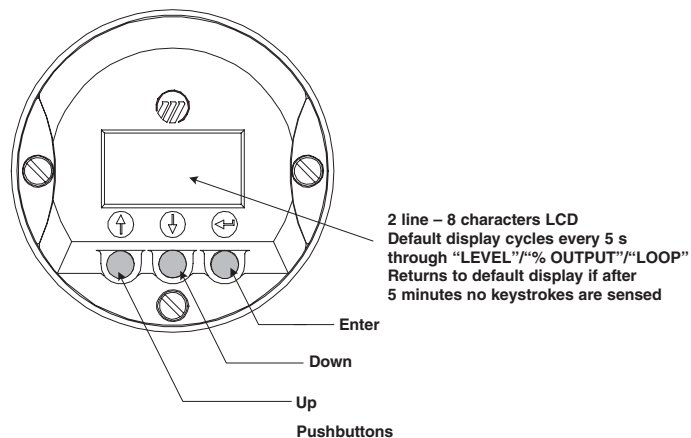

IMPORTANT: When the amplifier is not connected to a probe, the screen will show "NO LEVEL SIGNAL". Ignore this message for bench configuration.

CALIBRATION - TRANSMITTER WITH LCD SCREENMENU: STEP BY STEP PROCEDURE

Display	Comment
Units! cm	Press ↵: The last character on the first line of the display changes to "!". This sign confirms that the values/choices of the second line can be modified via the ↓ and ↑ push buttons.
Units! cm	Press ↑↓: * Scroll through the choices or increase/decrease the values on the second line of the display by ↓ and ↑ pushbuttons. * Accept values/choices as selected by ↵ pushbutton.
Units cm	Press ↑↓: Scroll through the menu.

TERMINOLOGY

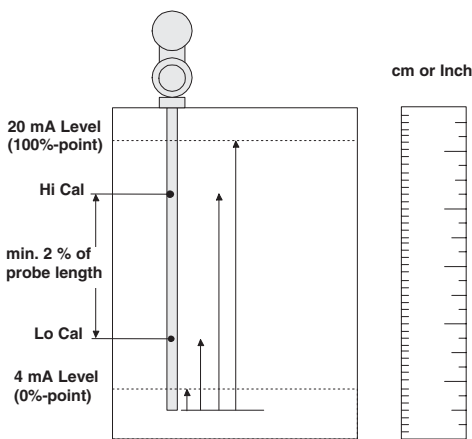



Units	cm or inches Select the units of measurement in which the unit will be calibrated and will show values.
20 mA Level	= [] cm or inches or 100 % level point, is measured from the end of the probe. Keep this reference point also for the introduction of all future values.
Hi Cal	= [] cm or inches High Calibration point is the highest level from which the calibration is performed. Hi Cal is measured from the end of the probe.
Lo Cal	= [] cm or inches Low Calibration point is the lowest level from which the calibration is performed. Lo Cal is measured from the end of the probe.
4 mA Level	= [] cm or inches or 0 % level point, is measured from the bottom of the probe. The 4 mA level is by preference located on the probe. The unit will not measure below the end of the probe.

NOTE: The above example shows the end of the probe as reference point. Also the bottom or top of the tank can be used as reference point. Whichever point is used, it must always be used for all further values.

Display	Action	Comment
Ent Pass 0	"0" means that no password is introduced	Factory default setting
Ent Pass! 1	Press ↵ and last character changes into "!" Enter a value between 1 up to 255 as your personal password with ↑ and ↓	Changing password
New Pass 4096	Display shows an encrypted value, enter your password or call Magnetrol for assistance to recoup your password if necessary	Data is protected by a valid Password
New Pass 0000	Protect data by new password	Data is not protected

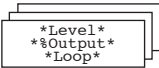
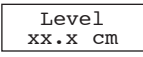
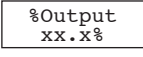
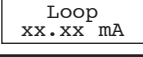
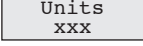
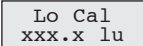
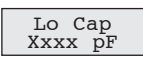
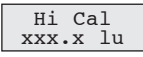
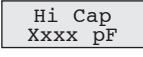
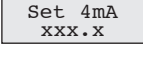
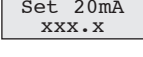
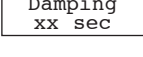
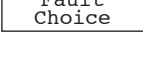
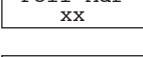
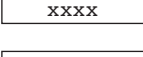
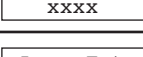
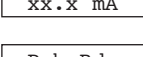
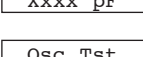
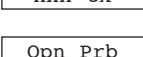
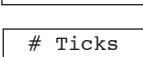
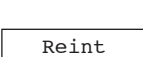
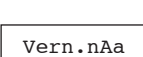
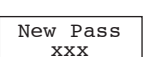
CALIBRATION - TRANSMITTER WITH LCD SCREENMENU: STEP BY STEP PROCEDURE

Screen	Action	Comment
Run mode	① 	Transmitter Display Transmitter default display. Level, % Output, and Loop values cycle every 5 seconds.
	② 	Transmitter Display Transmitter displays Level measurement in cm or in.
	③ 	Transmitter Display Transmitter displays % Output measurement derived from the 4-20 mA span.
	④ 	Transmitter Display Transmitter displays Loop measurement (mA).
Configuration	⑤ 	Select units for level measurement readout. cm or inches.
	⑥ 	Enter level value of the low calibration point Set level at low calibration point and adapt with Up and Down the displayed value
	⑦ 	Transmitter Display Transmitter displays capacitance at low calibration point in pF
	⑧ 	Enter level value of the high calibration point Set level at high calibration point and adapt with Up and Down the displayed value
	⑨ 	Transmitter Display Transmitter displays capacitance at high calibration point in pF
	⑩ 	Enter the level value for the 4 mA point. 4 mA level cannot be set at a lower level than the end of the probe
	⑪ 	Enter the level value for the 20 mA point. 20 mA level cannot be set at a higher level than the top of the probe
	⑫ 	Enter the damping factor. A Damping factor (1-45 seconds) may be added to smooth a noisy display and/or output due to turbulence.
	⑬ 	Enter the default value. Select 3.6 mA, 22 mA or HOLD (last value). 3.6 mA is not valid if unit includes HART.
	⑭ 	Enter HART ID number. Select a HART poll address (0-15). Enter 0 for a single transmitter installation.
	⑮ 	Fine tune the 4 mA point. Attach a mA meter to the output. If the output does not equal 4.0 mA, adjust the value on the display to equal 4.00 mA.
	⑯ 	Fine tune the 20 mA point. Attach a mA meter to the output. If the output does not equal 20.0 mA, adjust the value on the display to equal 20.00 mA.
Diagnostics	⑰ 	Enter a mA Output value. Set mA Output to any given value to perform loop test.
	⑱ 	None, do not adjust. Transmitter displays capacitance at present level
	⑲ 	None, do not adjust. Transmitter displays internal timing count with fixed capacitance (factory diagnostic)
	⑳ 	None, do not adjust. Transmitter displays internal timing count with probe disconnected (factory diagnostic)
	㉑ 	None, do not adjust. Transmitter displays internal timing count at present level (factory diagnostic)
	㉒ 	Reinitialize all values. Reinitialize - choose YES to reset all configuration values back to factory defaults.
	㉓ 	None, do not adjust. Transmitter displays version number of firmware
	㉔ 	Enter new password. Use arrows to select desired value. Values between 1 and 255



= min. required calibration

IMPORTANT: Check whether your HART® communicator is equipped with the 805 Device Descriptors (DD's). Older purchased devices may require an update – consult your local HART Service Centre or Magnetrol for further assistance.

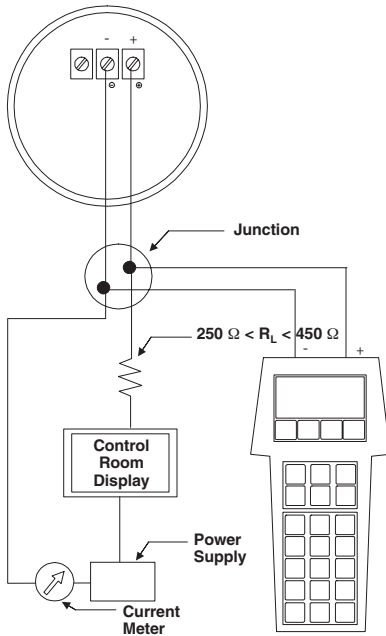

CONNECTIONS

Connection of your Hart communicator:

- at power terminals (+) and (-) in wiring compartment
- at first junction box between unit and control room.

IMPORTANT: The digital HART® communication is superimposed on the 4-20 mA loop and requires a min. load resistance of 250 Ω and a max load resistance of 450 Ω.

HART MENU

I/O Start up the device

1 Enter DEVICE SET UP

Press one of the following alphanumeric keys (if no key is sensed after 5 s, the unit will automatically jump to RUN mode and alternatively show Level/% Output and Loop signal

- 1 for entering CALIBRATION (see page 5 for additional information)
- 2 for entering BASIC SETUP – general HART
- 3 for ADVANCED SET UP CONFIGURATION (see page 5 for additional information)
- 4 for entering DIAGNOSTICS (see page 5 for additional information)
- 5 for entering REVIEW to review all settings.

<p>1 Device Setup 2 Level 3 % Output 4 Loop</p>	<p>1 Calibration</p>	<p>1 Units 2 Empty Calibration 3 Full Calibration 4 4 mA Set Point</p>	<p>5 20 mA Set Point 6 Damping 7 Fault State 8 Date/Time/Initials</p>
	<p>2 Basic Setup</p>	<p>1 Tag 2 Descriptor 3 Date 4 Message</p>	<p>5 Final Asmbly Num 6 Poll Address 7 New Password</p>
	<p>3 Advanced Setup/ Configuration</p>	<p>1 Adjust Trim 4 mA 2 Adjust Trim 20 mA 3 4 mA Trim Value 4 20 mA Trim Value</p>	<p>5 Enter Password 6 Set Magnetrol S/N 7 Set Dev ID Number</p>
	<p>4 Diagnostics</p>	<p>1 Loop Test 2 Error Codes 3 Probe Reading 4 Cap at empty Cal 5 Cap at full Cal</p>	<p>1 3.6 mA 2 4 mA 3 20 mA 4 22 mA 5 Other</p>
	<p>5 Review</p>	<p>1 Model 2 Manufacturer 3 Dev Id, S/N 4 Tag 5 Descriptor 6 Date 7 Message 8 Units 9 Cap at empty Cal 10 Cap at full Cal 11 4 mA Set Point</p>	<p>12 20 mA Set Point 13 Damping 14 Fault State 15 Date/Time/Initials 16 Final Asmbly Num 17 Universal Rev 18 Fld Dev Rev 19 Software Rev 20 Poll Address 21 Num Req Preams 22 Firmware Version</p>

MAINTENANCE

TROUBLESHOOTING SYSTEM PROBLEMS – LCD version

Symptom	Problem	Solution
LEVEL, % OUTPUT and LOOP values are all inaccurate.	Basic configuration data is questionable.	Check values and recalibrate if necessary (either or both points).
LEVEL readings are repeatable but consistently high or low from actual by a fixed amount.	Configuration data does not accurately match tank height.	Recalibrate if necessary.
LEVEL, % OUTPUT and LOOP values fluctuate.	Turbulence.	Increase the Damping factor until the readings stabilize.
LOOP value jittery, usually in tenths or hundredths digit.	Factory settings corrupted.	Check # of Ticks. If the number is also jittery, consult the Factory.
HART device only: handheld will only read Universal Commands.	Most current Device Descriptors (DDs) are not installed in handheld.	Contact local HART service center for the latest DDs.
HART device only; reads Product information (e.g., Mfgs. ID, Device #, Serial #, etc.) but will not read any process variables.	Early HART software does not account for Mfgs. ID #'s greater than 63. Magnetrol's ID is 86.	Contact manufacturer of your HART master software for upgrade. This is a shortcoming of early HART master software.

ERROR MESSAGES – LCD version

Symptom	Problem	Solution
OSC FAIL (HART error code = 0x40)	malfunctioning analog board and/or 32 pin connector (electronic module) between electronics and probe.	Check connection between electronics and probe or replace electronic module.
CORRUPT PARAMTRS (HART error code = 0x10)	Configuration parameters may have been lost.	Check all configuration parameters and recalibrate if required.
805 FAULT (Open)	Probe disconnected.	Check white probe wire (see page 2) and electronic module.
805 FAULT (Shorted)	Probe shorted.	Check white probe wire (see page 2) and probe insulation.
LEVEL (Uncal)	Unit is not calibrated.	Enter both Low and High calibration points.
ABV RNG (Above range)	Measured capacitance is higher than 12,000 pF.	Consult factory.
SFWR ERROR (Software error)	Software error.	Consult factory.

REPLACEMENT PARTS

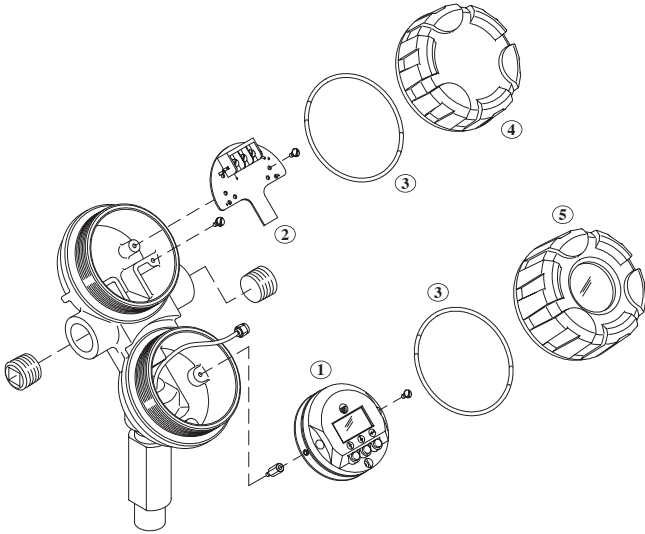

Item	Description	Part number
1	Electronic module	
	English display and HART®	031-2809-001
	French display and HART®	031-2809-031
	German display and HART®	031-2809-041
	Spanish display and HART®	031-2809-021
	HART® only	031-2809-002
	English display only	031-2809-003
	French display only	031-2809-033
	German display only	031-2809-043
	Spanish display only	031-2809-023
2	Terminal board	
	General Purpose (GP) Intrinsically Safe (IS)	30-9106-003 30-9106-003
3	O-Ring (neoprene)	12-2201-237
4	Housing cover blind - Aluminium	04-9193-003
	Housing cover blind - 316 SST	Consult factory
5	Housing cover with glass	36-4410-001
	Housing cover with glass - 316 SST	Consult factory

APPROVALS

Agency	Description
ATEX	II 1G EEx ia IIC T4 (ambient -40° C to +40° C) II 1G EEx ia IIC T6 (ambient -40° C to +80° C)
FM (*)	Intrinsically safe Class I, Div.1; Grps. A, B, C, D Class II, Div.1; Grps. E, F, G Class III, NEMA 4X Non-Incendive Class I, Div.2; Grps. A, B, C, D Class II, Div.2; Grps. F, G Class III, NEMA 4X (*) Consult factory for proper part n° and entity parameters.

Agency	Description
CSA (*)	Intrinsically safe Class I, Div.1; Grps. A, B, C, D Class II, Div.1; Grp. G Class III, Type 4X Non-Incendive Class I, Div.2; Grps A, B, C, D Class II, Div.2; Grps E, F, G Class III, Type 4X (*) Consult factory for proper part n° and entity parameters.

TROUBLESHOOTING FLOWCHART (LCD version)

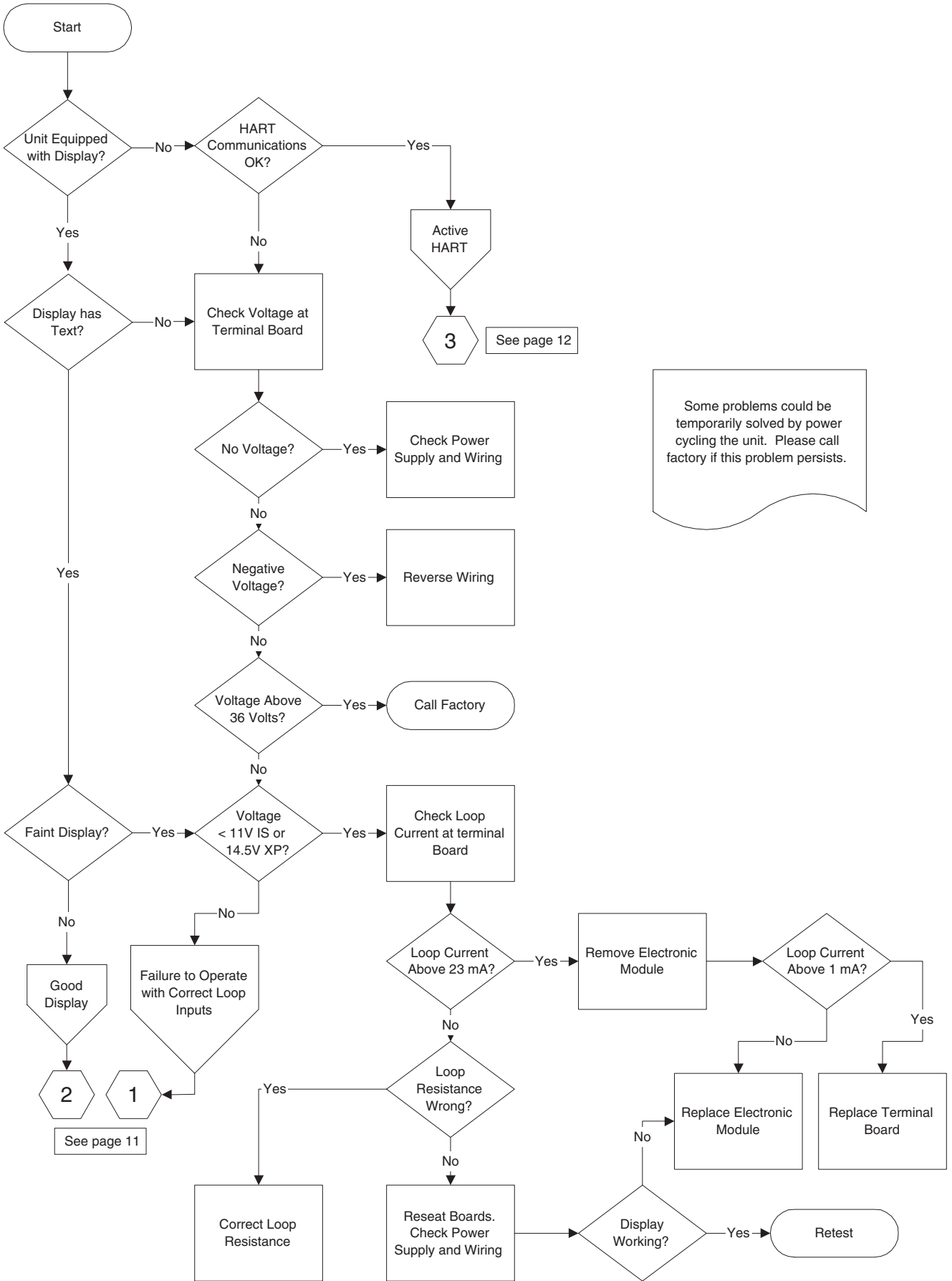

TROUBLESHOOTING FLOWCHART (LCD version)

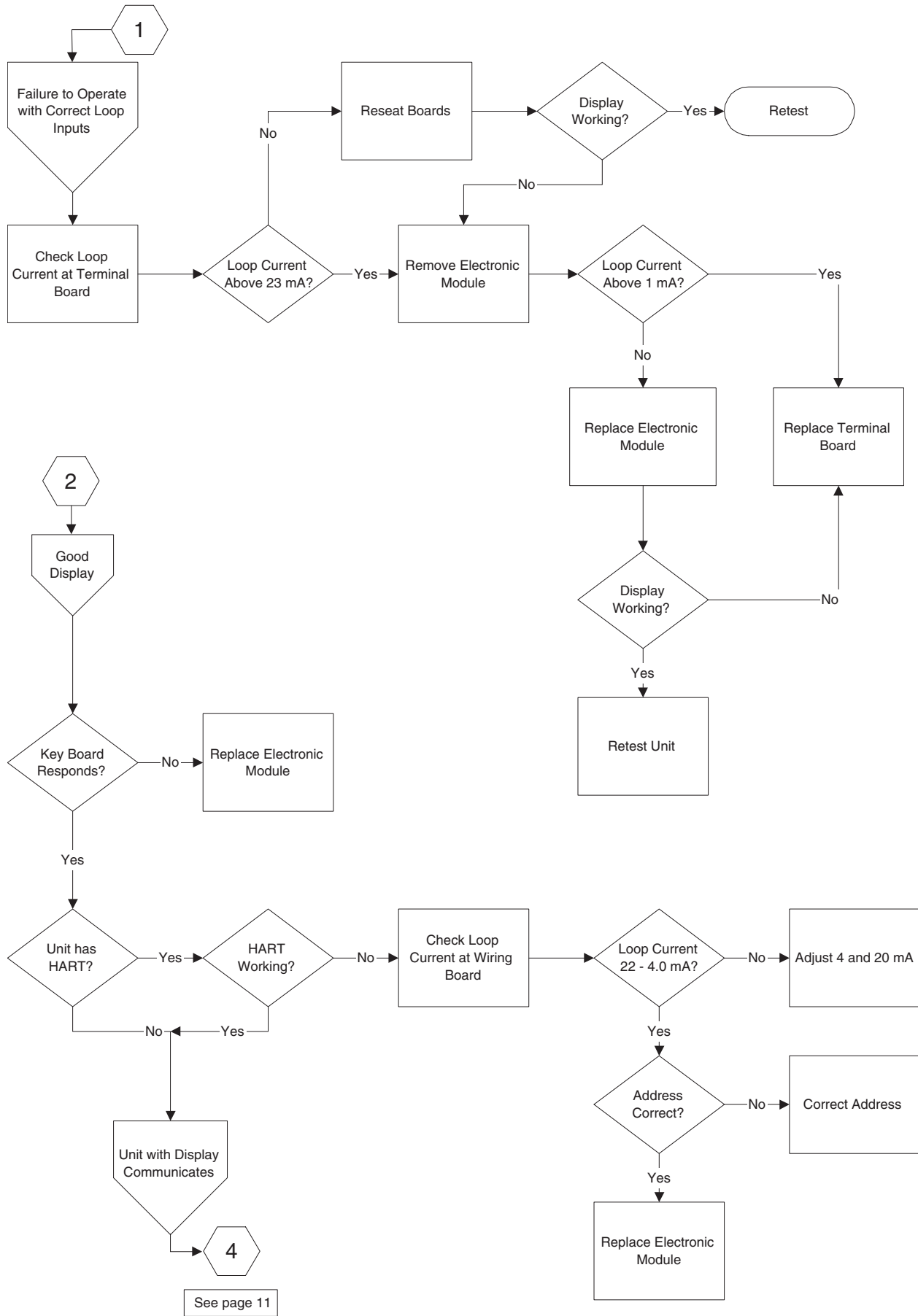

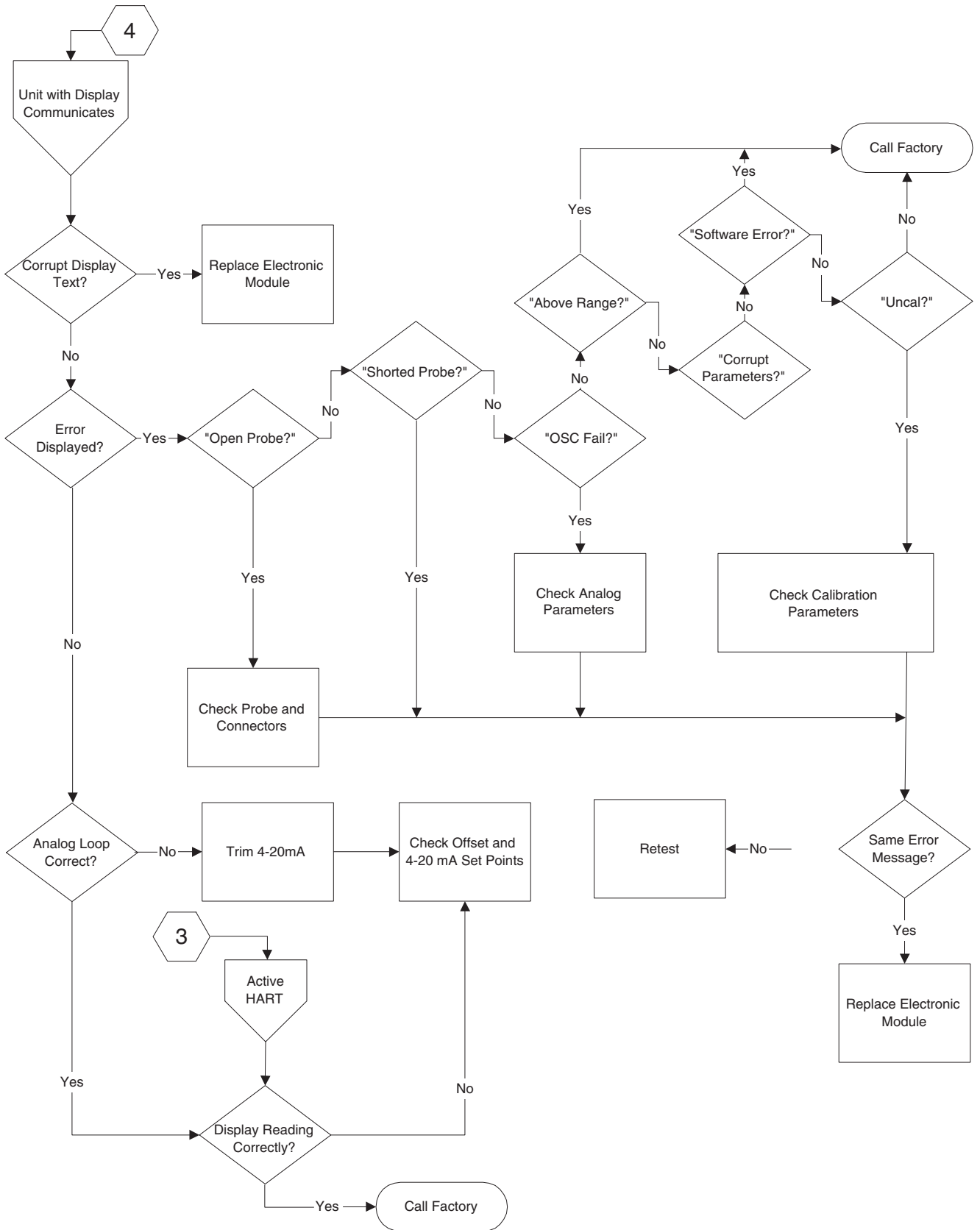

TRANSMITTER SPECIFICATIONS

FUNCTIONAL/PHYSICAL

Description	Specification
Power (at terminals)	General Purpose: 11 to 36 V DC ATEX Intrinsically Safe: 11 to 28.6 V DC
Signal Output	4-20 mA or 4-20 mA with HART® 3.8 to 20.5 mA useable (meets NAMUR NE 43)
Span	minimum 5 pF - maximum 10.000 pF
Zero and Range	0 mm to 45 m (0' to 150')
Resolution	Analog: 0.01 mA Digital display: 0,1 cm (0.1")
Loop Resistance	ATEX Intrinsically Safe/General Purpose: 650 Ω @ 24 V DC
Damping	Adjustable 1-45 s
Diagnostic Alarm	Adjustable 3.6 mA, 22 mA, HOLD (3.6 mA is not valid if unit includes HART®)
Digital Communication (HART®)	compatible with software version 5.x
User Interface	3-button keypad and/or HART communicator
Display	2-line x 8-character LCD
Approvals	ATEX II 1 G EEx ia IIC T4/T6 or FM/CSA intrinsically safe / non incensive
Electrical Data	U _i = 28,6 V, I _i = 140 mA, P _i = 1 W
Equivalent Data	C _i = 2,2 nF; L _i = 0,037 mH
Menu Language	English/Spanish/French or German
Housing Material	Aluminium A356T6 (< 0.25% copper) or 316 SST (1.4401)/IP 65
Net and Gross Weight	2.70 kg net; 3.20 kg gross
Overall Dimensions	H 214 mm (8.43") x W 111 mm (4.38") x D 188 mm (7.40")

PROCESS CONDITIONS

Description	Specification
Maximum Process Temperature	540 °C @ 35 bar (1000 °F @ 500 PSIG) - depending probe selection
Maximum Process Pressure	345 bar @ 40 °C (5000 PSIG @ 100 °F) - depending probe selection
Ambient temperature electronics	-40 °C to +80 °C (-40 °F to +175 °F) – blind transmitter -20 °C to +70 °C (-5 °F to +160 °F) – with LCD display and keypad
Storage temperature	-40 °C to +80 °C (-40 °F to +175 °F)
Humidity	0-99 %, non-condensing
Electromagnetic Compatibility	Meets CE requirements (EN-50081-2, EN 50082-2) / NAMUR NE 21 (EMV)

PERFORMANCE

Description	Specification
Reference conditions	20 °C (70 °F)
Accuracy	+/- 0.5% of span or 2.5 mm whichever is greater
Resolution	0.1 pF
Repeatability	+/- 0.1% of span
Linearity	+/- 0.25% of span
Response time	less than 1 s (adjustable via damping)
Ambient temperature effect	approximately +0.03% per °C
Warm up time	less than 5 s

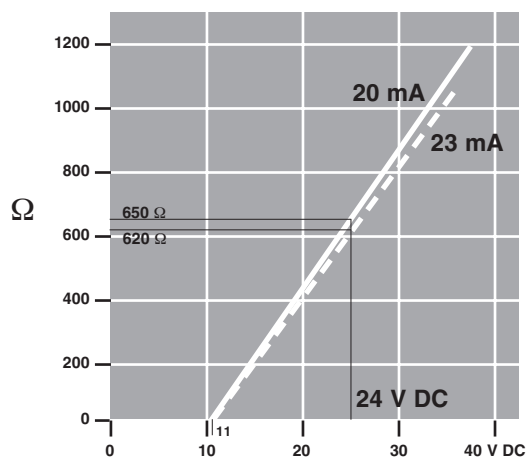

OUTPUT TABLE

DIMENSIONS in mm (inches)

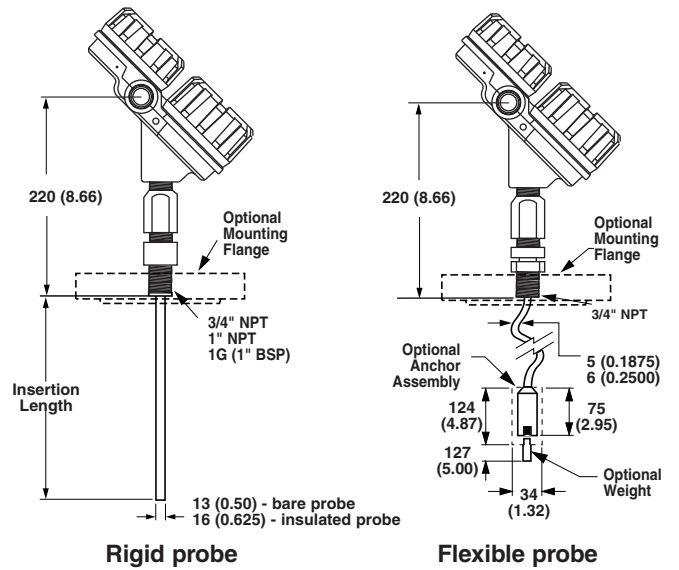
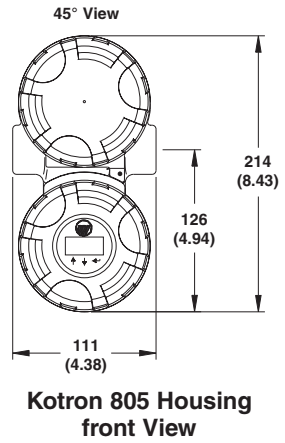
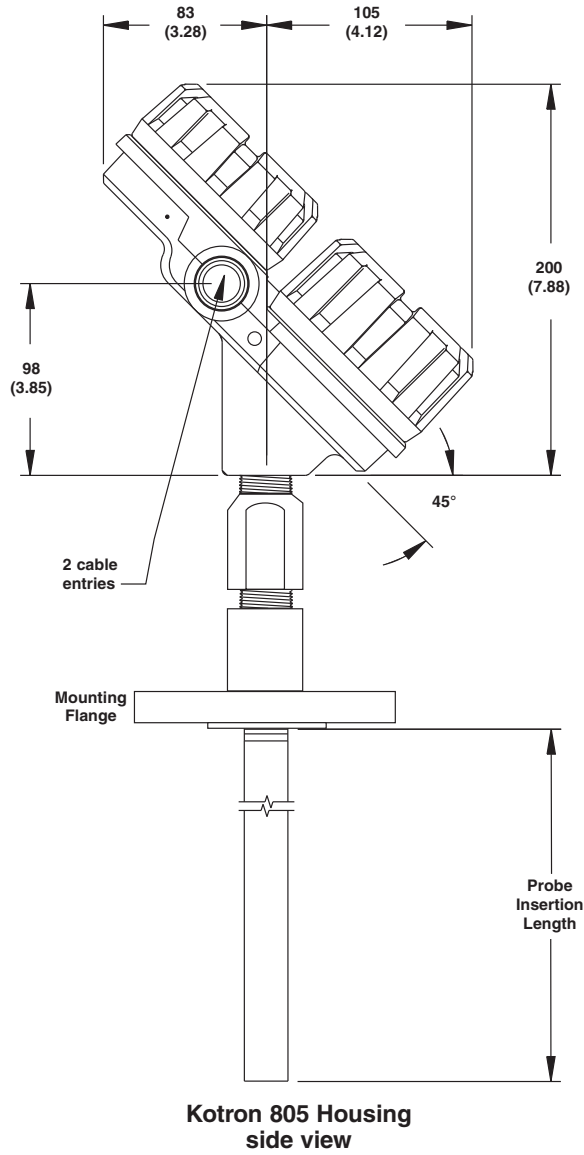

CONNECTIONS

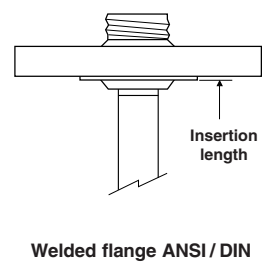
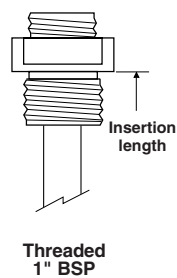
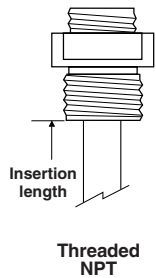
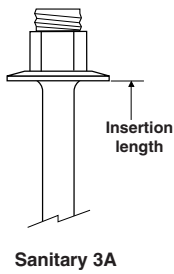

IDENTIFICATION

A complete measuring system consists of a:

1. Smart R.F. KOTRON® 805 amplifier.
2. KOTRON® Probe; a full range of rigid and flexible probes for conductive and non-conductive media is available (see bulletin BE 50-125).
Rigid probes: from 150 mm (6") to 6000 mm (20') insertion length
Flexible probes: from 1 m (3,28') to 45 m (150') insertion length
3. OPTION: HART communicator
Magnetrol P/N : **089 - 5213 - 012** (Euro Plug) **089 - 5213 - 013** (UK Plug)

1. Code for SMART R.F. KOTRON® 805 amplifier

BASIC MODEL NUMBER

8	0	5	Smart R.F. KOTRON® 805 amplifier
---	---	---	----------------------------------

SIGNAL OUTPUT

0	4 - 20 mA analog output
1	4 - 20 mA analog output with HART® communication

MENU LANGUAGE

0	None, for use with blind transmitter (requires HART® communication)
1	English for use with transmitter with LCD display and keypad
2	Spanish for use with transmitter with LCD display and keypad
3	French for use with transmitter with LCD display and keypad
4	German for use with transmitter with LCD display and keypad

TRANSMITTER TYPE

0	Blind transmitter (requires HART® communication)
A	Transmitter with 2 line x 8 character LCD display and keypad

APPROVALS

1	General Purpose (FM/CSA intrinsically safe)
A	Intrinsically safe, ATEX II 1G EEx ia II C T6

HOUSING

1	Cast aluminium, dual compartment housing – IP 65
2	Stainless steel, dual compartment housing – IP 65

CABLE ENTRY

0	3/4" NPT (2 entries - one plugged)
1	M20 x 1.5 (2 entries - one plugged)
2	PG 13.5 (2 entries - one plugged)

8	0	5	5				
---	---	---	---	--	--	--	--

complete code for SMART R.F. KOTRON® 805 amplifier

IMPORTANT

SERVICE POLICY

Owners of Magnetrol products may request the return of a control; or, any part of a control for complete rebuilding or replacement. They will be rebuilt or replaced promptly. Magnetrol International will repair or replace the control, at no cost to the purchaser, (or owner) **other than transportation cost** if:

- a. Returned within the warranty period; and,
- b. The factory inspection finds the cause of the malfunction to be defective material or workmanship.

If the trouble is the result of conditions beyond our control; or, is **NOT** covered by the warranty, there will be charges for labour and the parts required to rebuild or replace the equipment.

In some cases, it may be expedient to ship replacement parts; or, in extreme cases a complete new control, to replace the original equipment before it is returned. If this is desired, notify the factory of both the model and serial numbers of the control to be replaced. In such cases, credit for the materials returned, will be determined on the basis of the applicability of our warranty.

No claims for misapplication, labour, direct or consequential damage will be allowed.

RETURNED MATERIAL PROCEDURE

So that we may efficiently process any materials that are returned, it is essential that a "Return Material Authorisation" (RMA) form will be obtained from the factory. It is mandatory that this form will be attached to each material returned. This form is available through Magnetrol's local representative or by contacting the factory. Please supply the following information:

1. Purchaser Name
2. Description of Material
3. Serial Number and Ref Number
4. Desired Action
5. Reason for Return
6. Process details

All shipments returned to the factory must be by prepaid transportation. Magnetrol **will not accept** collect shipments.

All replacements will be shipped FOB factory.

BULLETIN N°: BE 50-660.1
EFFECTIVE: APRIL 2002
SUPERSEDES: March 2000

UNDER RESERVE OF MODIFICATIONS



www.magnetrol.com

BENELUX	Heikensstraat 6, 9240 Zele, België Tel. +32 (0)52.45.11.11 • Fax. +32 (0)52.45.09.93 • E-Mail: info@magnetrol.be
DEUTSCHLAND	Schloßstraße 76, D-51429 Bergisch Gladbach-Bensberg Tel. 02204 / 9536-0 • Fax. 02204 / 9536-53 • E-Mail: vertrieb@magnetrol.de
FRANCE	Le Vinci 6 - Parc d'activités de Mitry Compans, 1, rue Becquerel, 77290 Mitry Mory Tél. 01.60.93.99.50 • Fax. 01.60.93.99.51 • E-Mail: magnetrolfrance@magnetrol.fr
ITALIA	Via Arese 12, I-20159 Milano Tel. (02) 607.22.98 (R.A.) • Fax. (02) 668.66.52 • E-Mail: mit.gen@magnetrol.it
UNITED KINGDOM	Unit 1 Regent Business Centre, Jubilee Road Burgess Hill West Sussex RH 15 9TL Tel. (01444) 871313 • Fax (01444) 871317 • E-Mail: sales@magnetrol.co.uk
INDIA	B4/115 Safdurjung Enclave, New Delhi 110 029 Tel. 91 (11) 6186211 • Fax 91 (11) 6186418 • E-Mail: magnetrolindia@vsnl.com